

CHAIN GUIDE TENERE 700

CRUNA CATENA TENERE 700

ACERBIS

COD. 500007886

ACERBIS PARTS

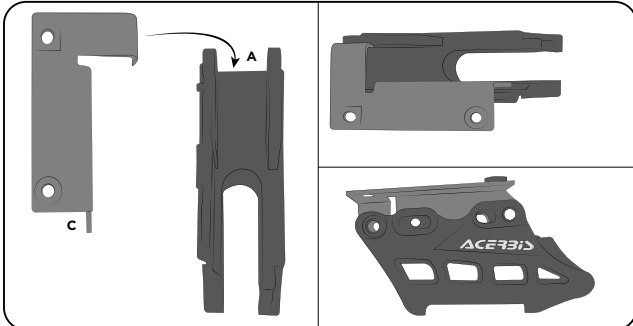
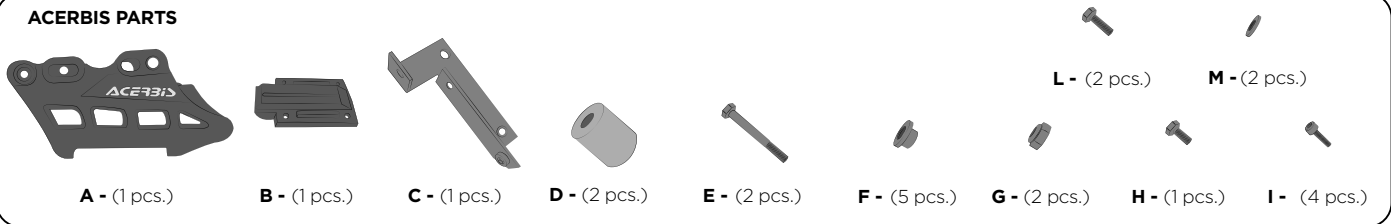

1 - Place the bracket (C) on the chain guide (A) as shown in figure.

1 - Posizionare la staffa (C) sul cruna (A) come indicato in figura.

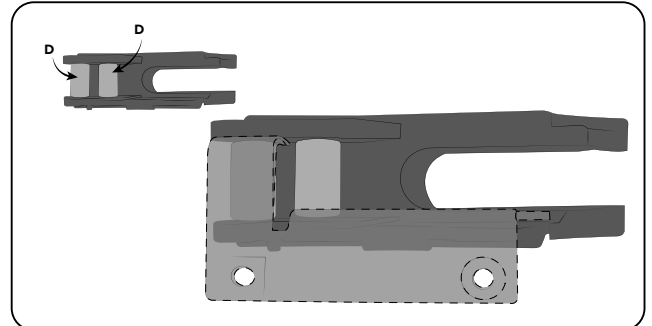

2 - Insert the bushings in the bracket (D) as shown in figure, and be careful to match the holes.

2 - Incastrare le boccole con la staffa (D) come indicato in figura, facendo combaciare i fori.

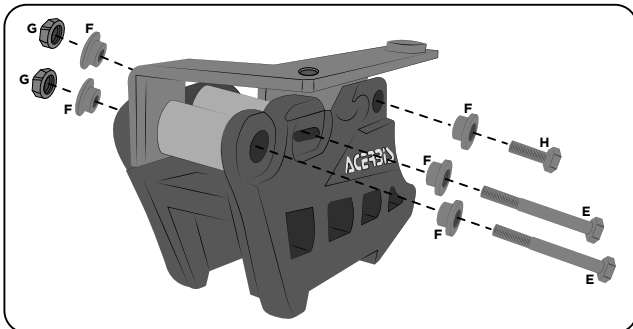

3 - Fix the flange using two screws (E), five bushings (F), one screw (H) and two nuts (G).

3 - Fissare la flangia attraverso due viti (E), cinque boccole (F), una vite (H) e due dadi (G).

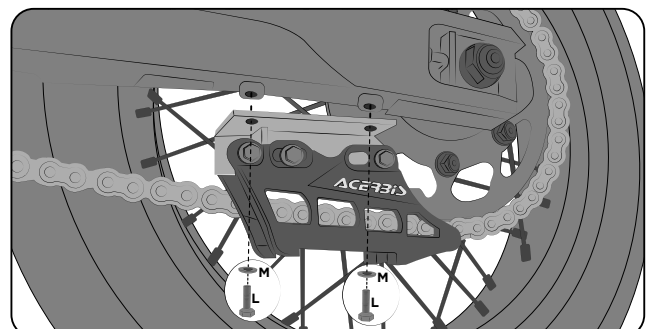

4 - Attach the chain guide on the bike and tighten using screws (L) and washers (M).

4 - Fissare il cruna catena sulla moto e avvitare tramite viti (L) e rondelle (M).

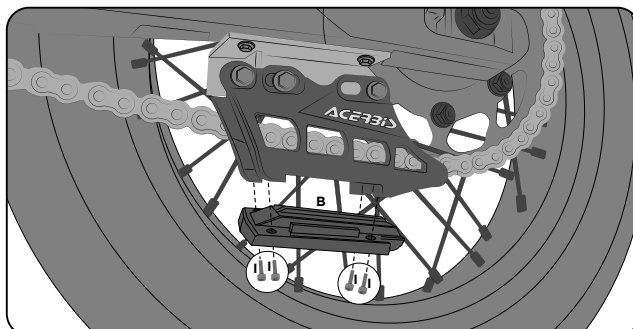

5 - Finally, attach the slipper (B) to the chain guide using four screws (I). Closing torque 2 Nm.

5 - Infine assemblare il pattino cruna (B) tramite quattro viti (I). Coppia di chiusura 2 Nm.

WARNING!

Use at your own risk. Check the security of your device before you ride. Be sure that you follow the instructions installing the Acerbis products. Do not ride if there is missing or damaged hardware. If this is the case, take the item immediately back to your dealer. Acerbis recommends that installation must be done by a licensed mechanic and that only Acerbis original parts are used during fitting. Acerbis makes no guarantees or representations, express or implied, regarding the fitness of its products for any particular purpose. Acerbis makes no guarantees or representations, express or implied, regarding the extent to which its product protect individuals or property from injury or death or damage.