

COD. 500005427 REV2

**ACERBIS PARTS**

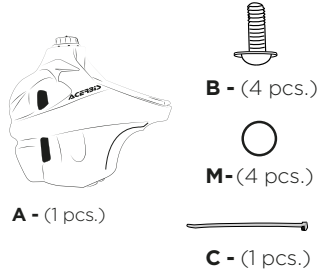

**O.E.M ITEMS TO USE**

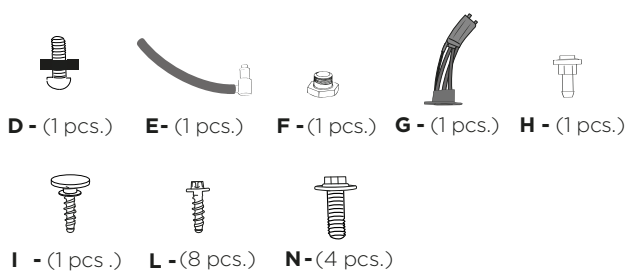

**ACERBIS PARTS ONLY FOR US TANKS**

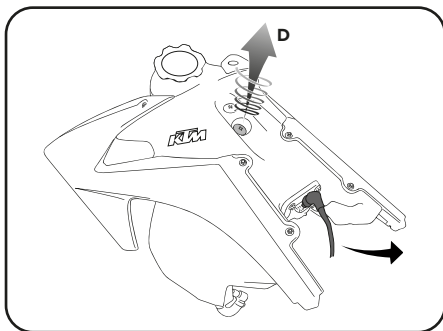
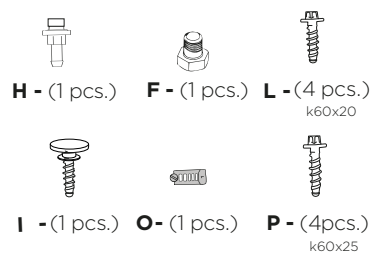

**1.** Svitare la vite serbatoio D. Sconnettere il cavo di alimentazione della pompa.  
**Remove the tank screws D. Disconnect the fuel pump power cable.**

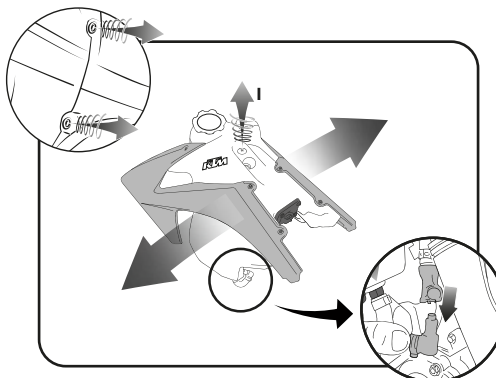

**2.** Rimuovere i fianchetti, le due viti radiatore, la vite-sella I, il serbatoio KTM e scollegare il connettore benzina.  
**Remove the radiator scoops, the two radiator screws, the seat screw I, the KTM tank and the fuel connector.**

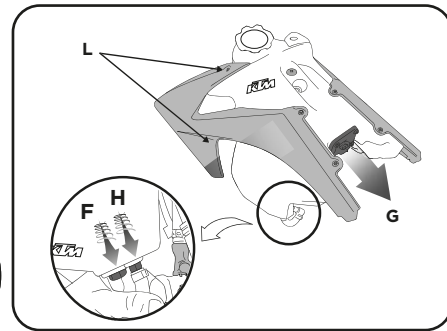

**3.** Svuotare completamente la benzina dal serbatoio, rimuovere le utenze e la pompa G.  
**Empty your fuel tank completely and remove the fasteners and the pump G.**

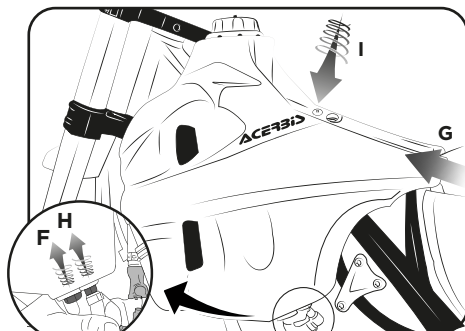

**4.** Montare il serbatoio Acerbis sulla moto, rimontare la pompa G, con 4 viti P e le utenze, avvitare la vite-sella.  
**Arrange the tank on the bike, reconnect the pump G, with the 4 screws P, the fasteners and screw the seat.**

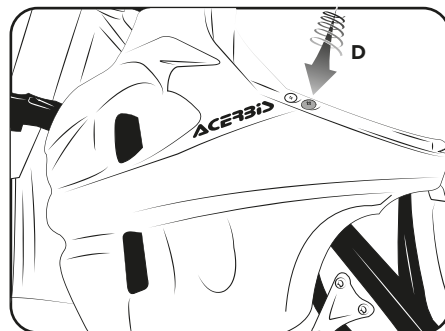

**5.** Avvitare la vite serbatoio.  
**Screw the tank screw.**

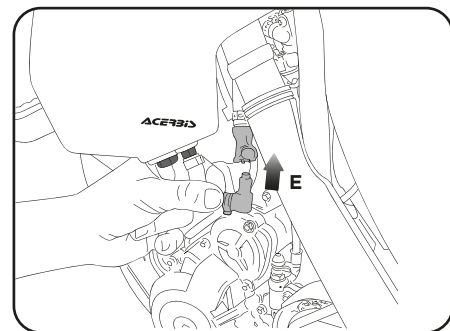

**6.** Riconnettere connettore benzina.  
**Reconnect the fuel connector.**

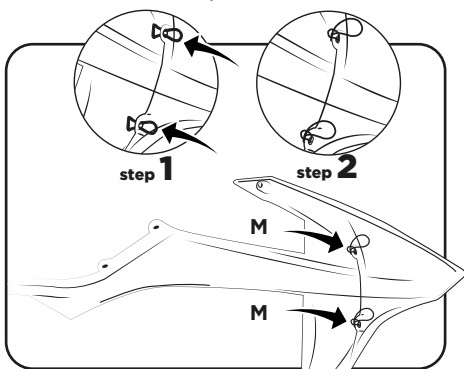

**7.** Allacciare gli O-ring M ai fianchetti nel modo indicato.  
**Fasten the O-rings M to the radiator scoops, as shown.**

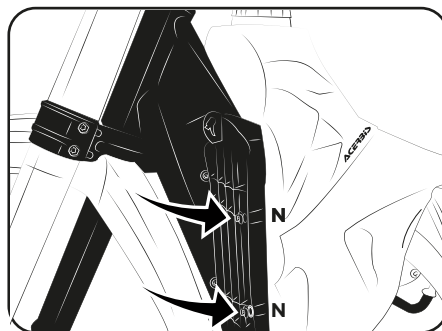

**8.** Avvitare le viti di fissaggio ai radiatori.  
**Tighten the screws N to the radiators.**

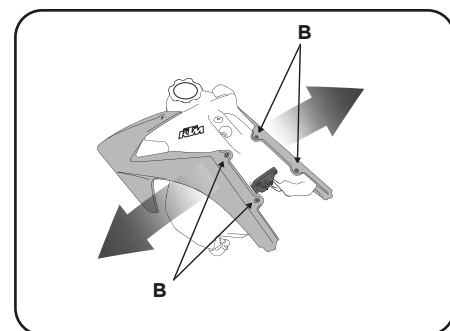

**9.** Rimontare i fianchetti con le 4 viti B in dotazione.  
**Remounting the radiator scoops with 4 screws B.**

KTM FUEL TANK SXF 15L '16  
**SERBATOIO KTM SXF 15 L '16**  
**SXF 250/350/450**  
**EXCF 250/350/450/500**

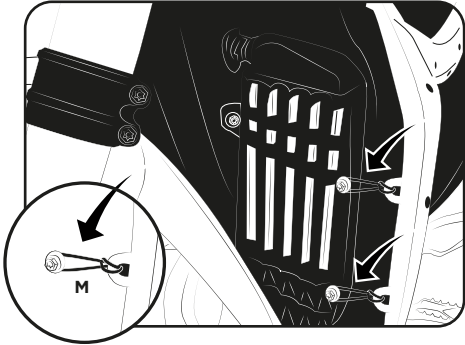

**10.** Fissare anteriormente gli O-ring M alle viti precedentemente installate.  
**Fasten the O-rings M on the screws previously installed.**

**ATTENZIONE: Dettaglio montaggio tubo-pompa**  
**ATTENTION: Pump hose mounting detail**

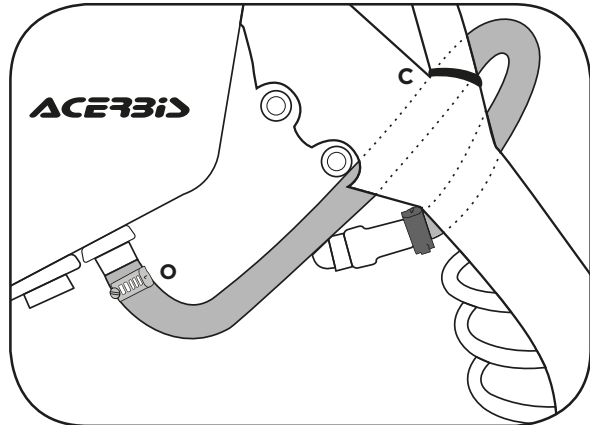

Fissare il tubo pompa KTM nel modo indicato: usare la fascetta Acerbis in dotazione facendo attenzione che il tubo piegandosi non crei strozzature.  
**Fix the pump hose KTM as illustrated: use the Acerbis strap included make sure that the hose doesn't fold obstructing the fluid.**



Thank you for purchasing an ACERBIS fuel tank

## WARNING

It is **EXTREMELY IMPORTANT** that the fuel tank be properly installed. To ensure proper installation, it is **STRONGLY RECOMMENDED** that the tank be installed only by a qualified OEM licensed dealership mechanic. Improper installation could result in serious injury or even death.

**If self-installed NOTE THE FOLLOWING.** Particular attention must be paid to excessive fuel line length and fuel line proximity to hot engine areas and pipes to prevent fire.

Clean tank interior thoroughly before installation. Install this fuel tank only in a well ventilated area, as gasoline fumes are extremely dangerous. Do not start or operate the vehicle if there are any fuel leaks! Read all instruction first before beginning installation.

## DISCLAIMER

Due to uncontrolled variables in the manufacturing process of rotationally molded fuel tanks, the fuel tank may vary in size and shape by up to 7% of the manufacturer's original listed capacity.

### DISCLAIMER:

DISCLAIMER: Due to uncontrolled variables in the manufacturing process of rotationally molded fuel tanks, the fuel tank may vary in size and shape by up to 7% of the manufacturer's original listed capacity.

### LIBERATORIA

LIBERATORIA: A causa di variabili inponderabili nel processo di stampaggio rotazionale dei serbatoi, questi possono differire in forma e dimensioni fino al 7% rispetto alla capacità dichiarata.

**FOR COMPETITION USE ONLY**  
**SOLO PER USO AGONISTICO**